

Mekong

Design
Soren Roberts

LDraw model/instructions
Lester Ward

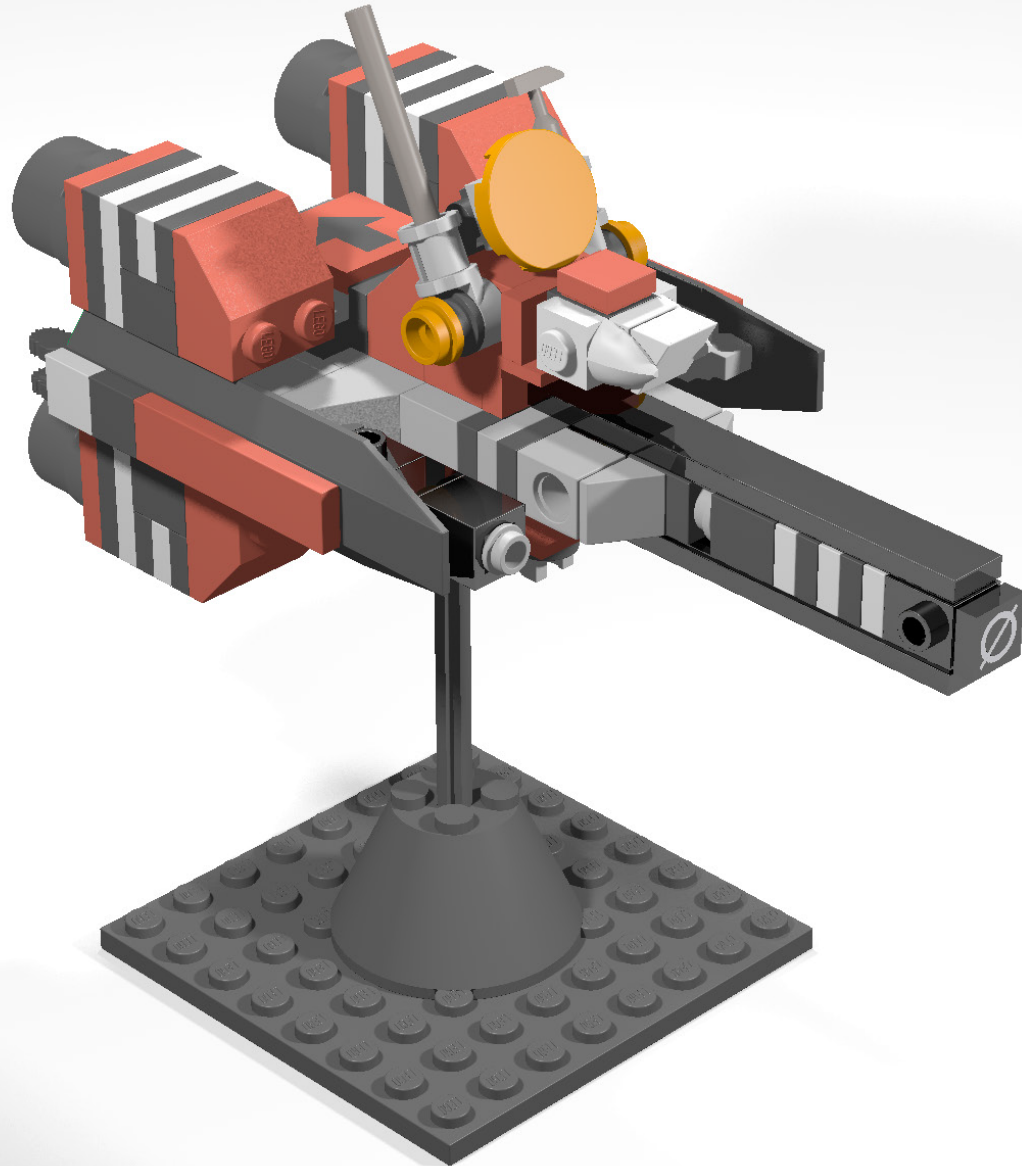

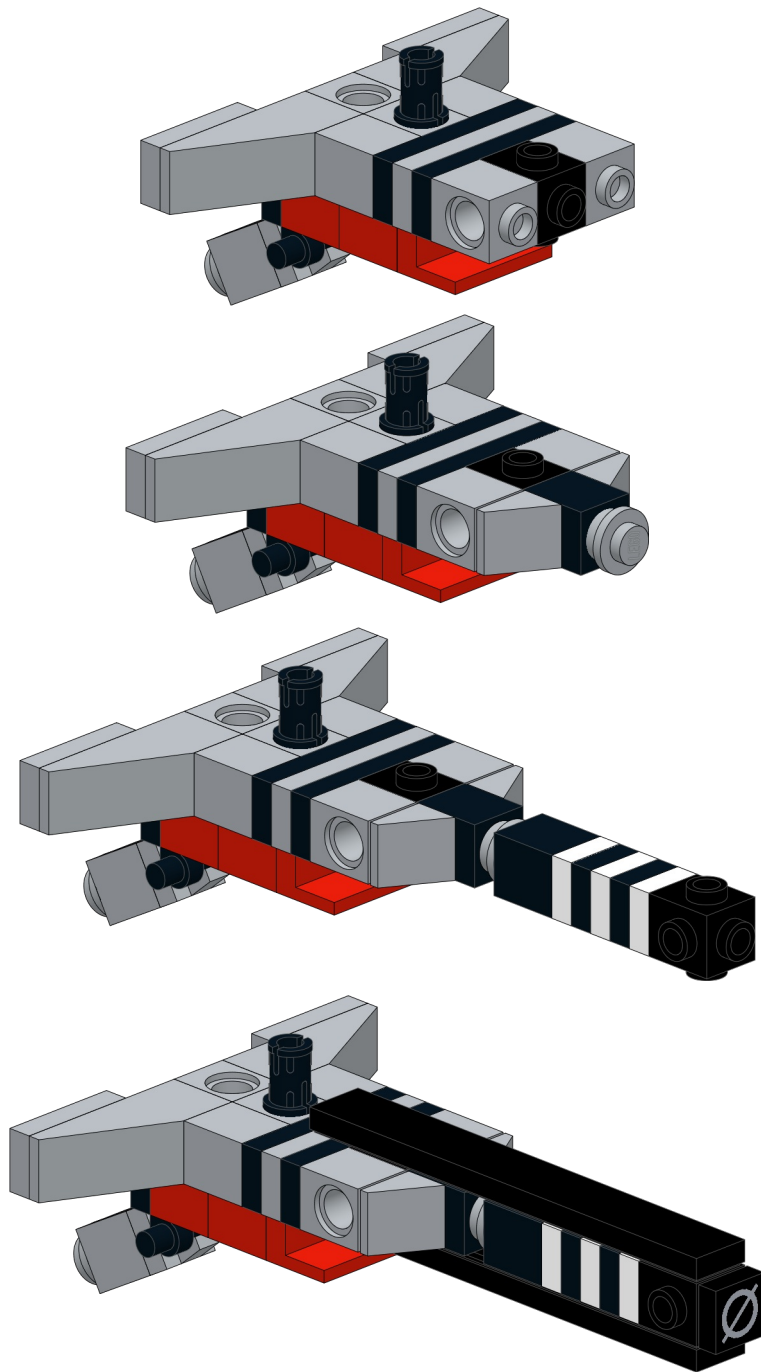
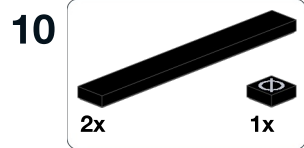
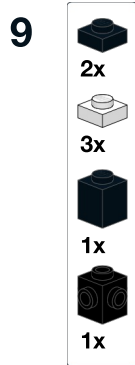
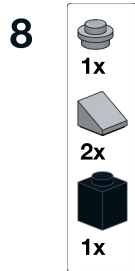
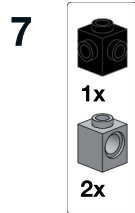
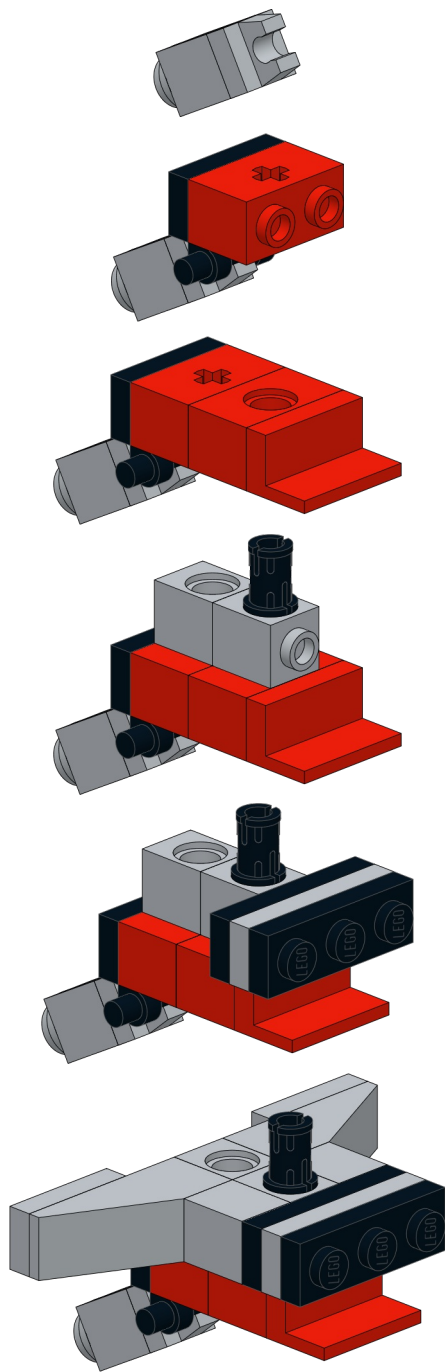
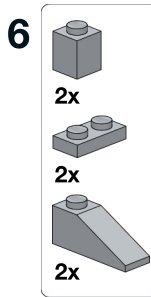
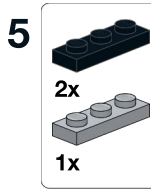
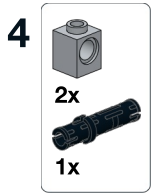
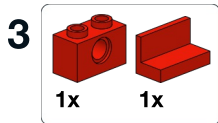
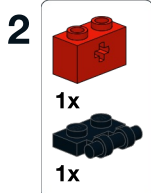
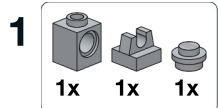

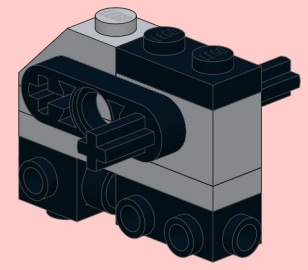
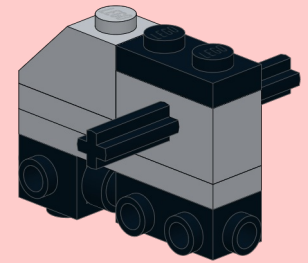
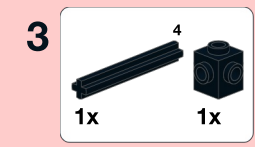
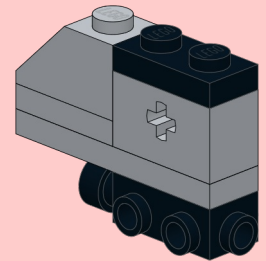
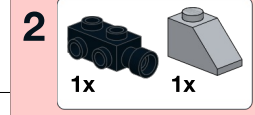
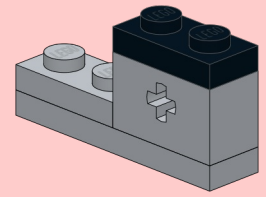
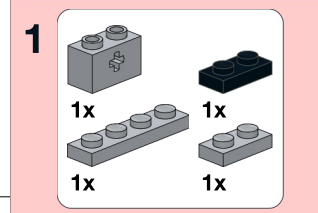
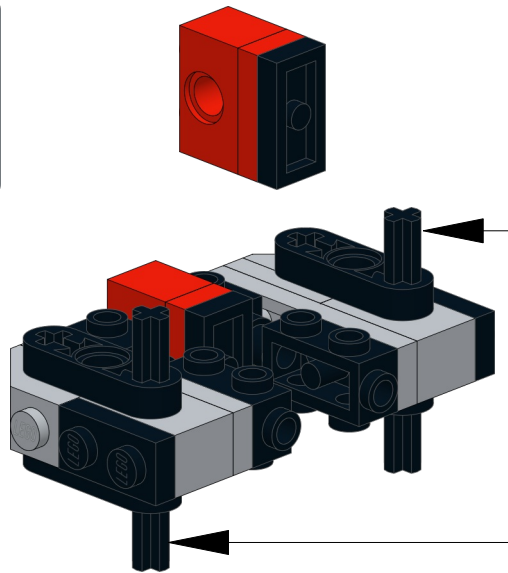
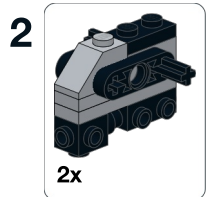
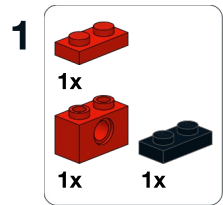

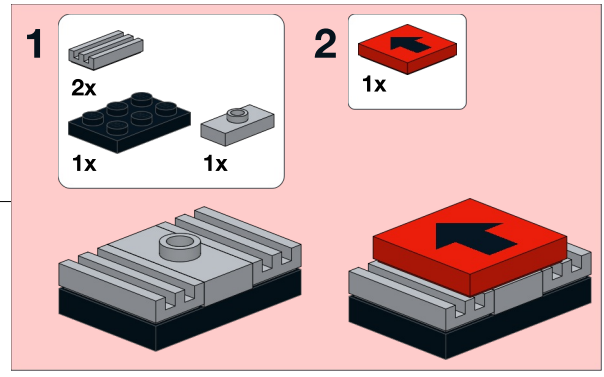
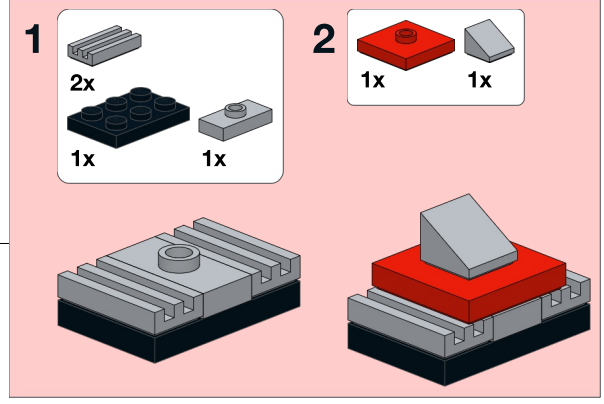
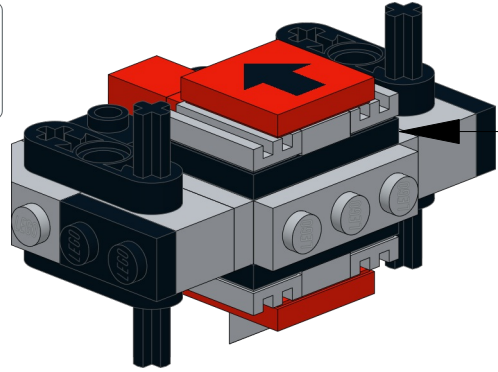
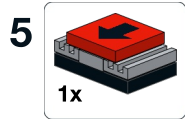
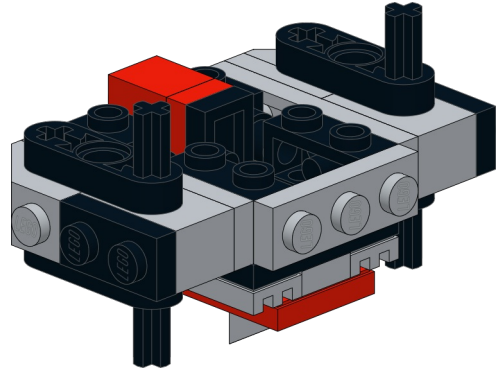
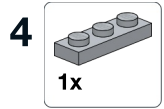
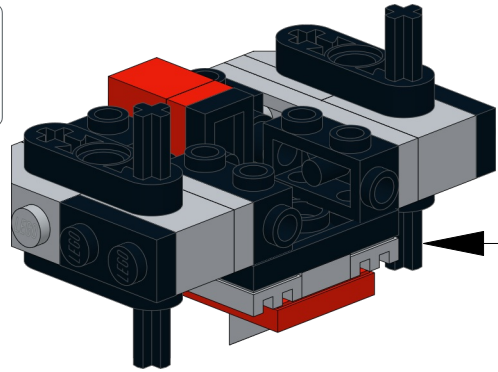
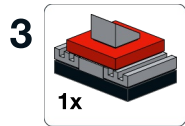

6

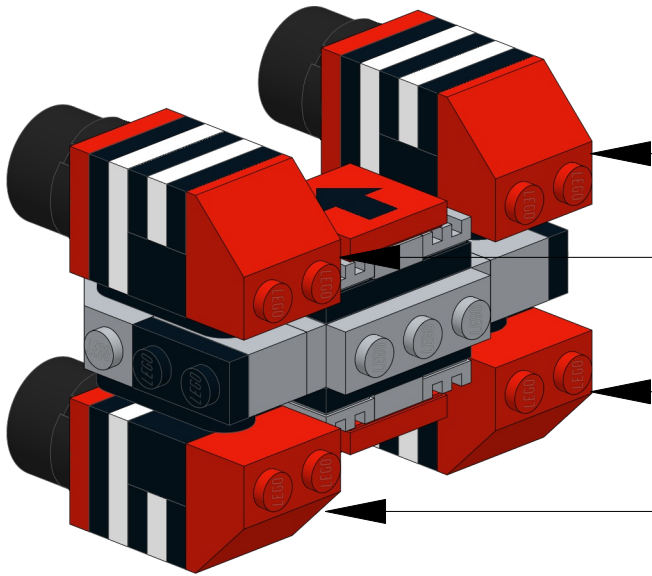

<p>1</p> <p>1x 1x</p>	<p>2</p> <p>1x</p>	<p>3</p> <p>1x 1x</p>
<p>4</p> <p>1x 1x</p>	<p>5</p> <p>1x 2x</p>	<p>6</p> <p>1x</p>

11

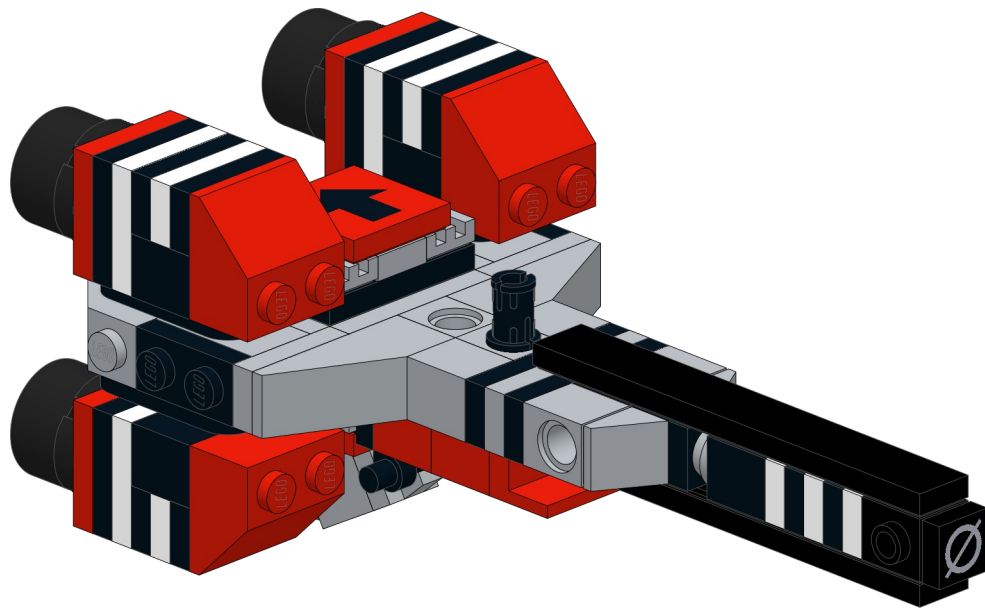
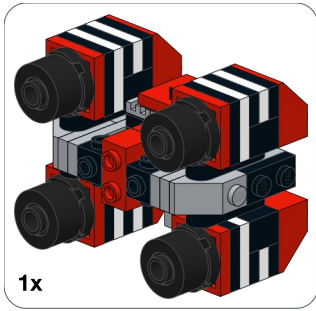

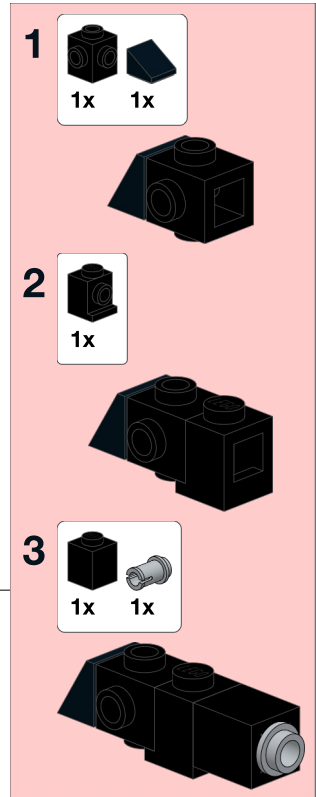
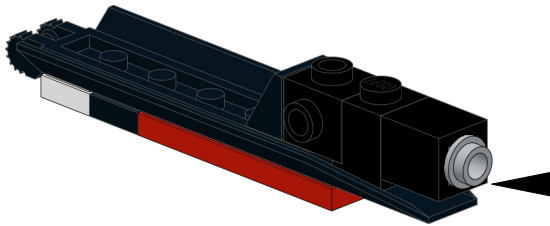
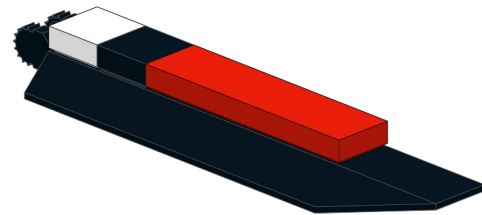
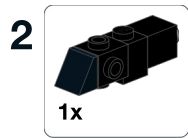
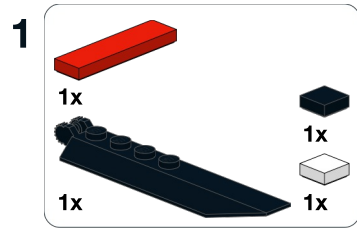

12

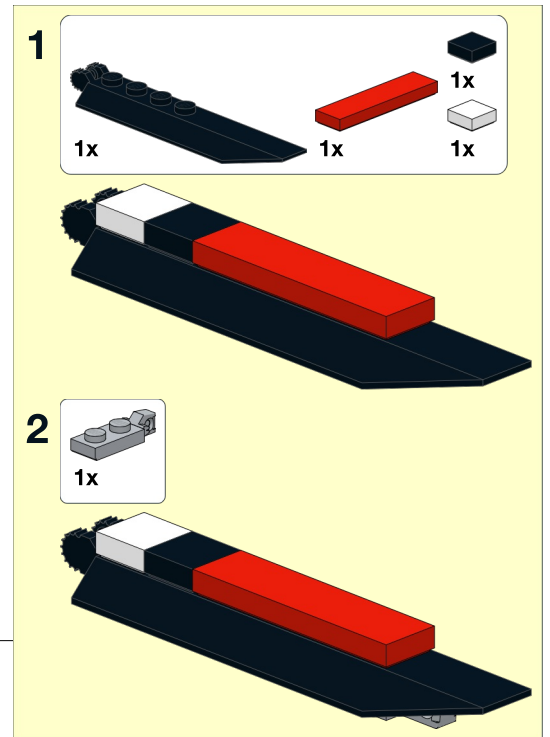
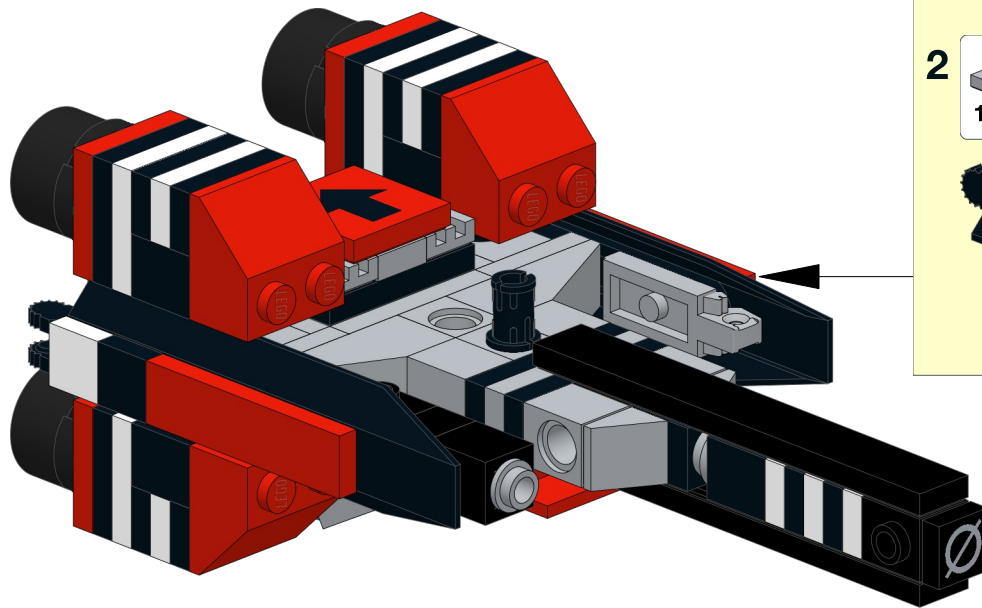
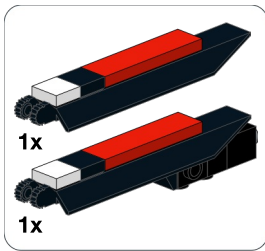

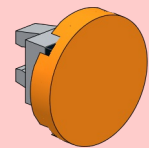
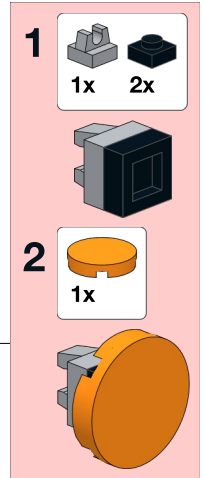
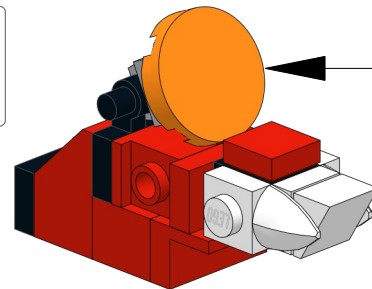
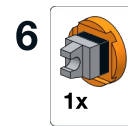
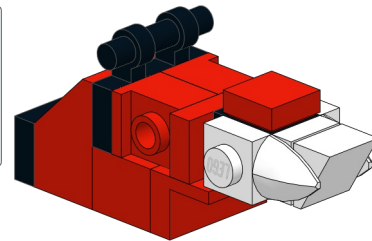
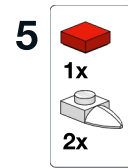
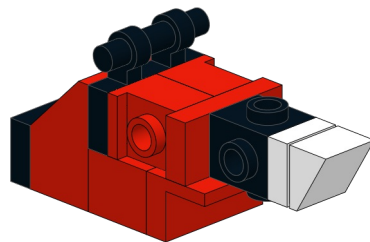
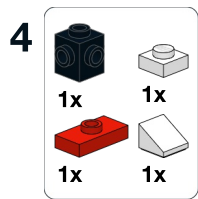
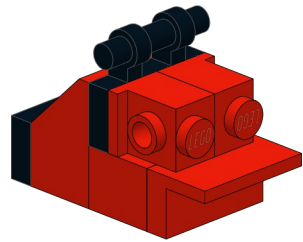
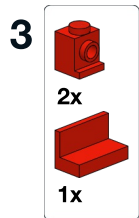
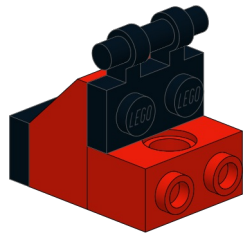
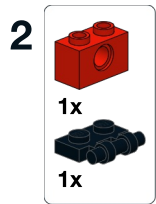
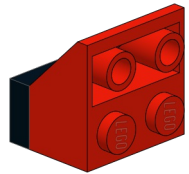
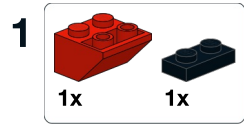

7

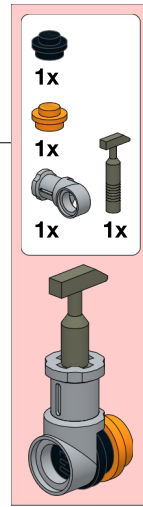
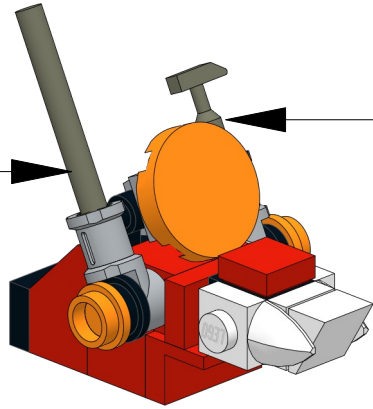
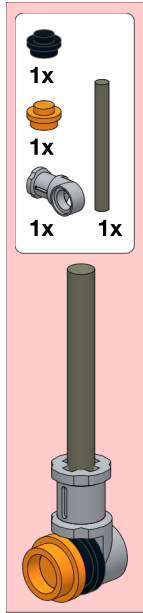
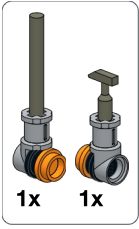

13

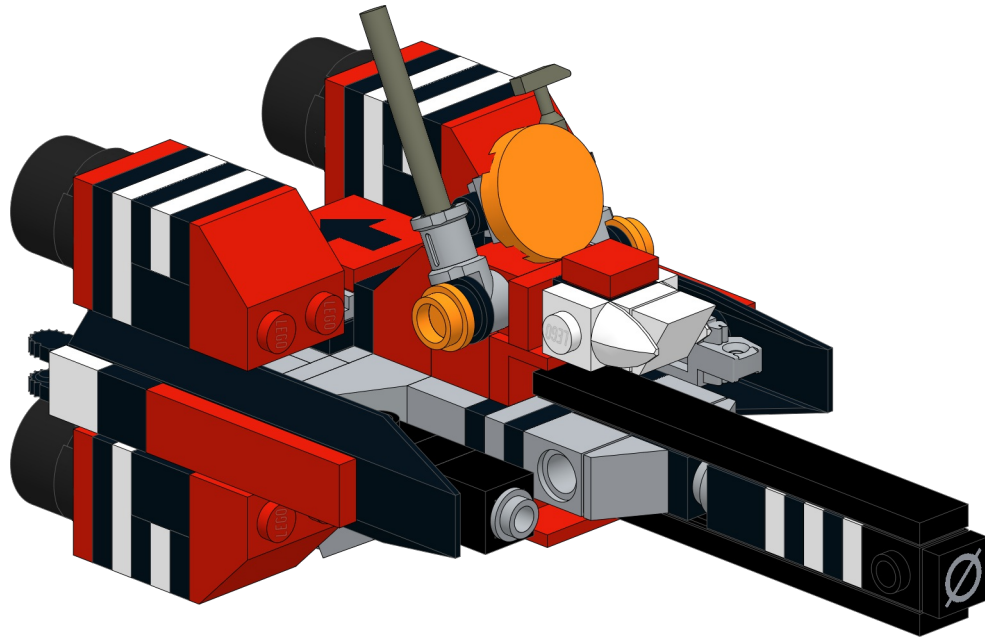
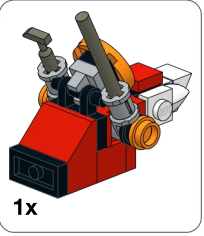

1

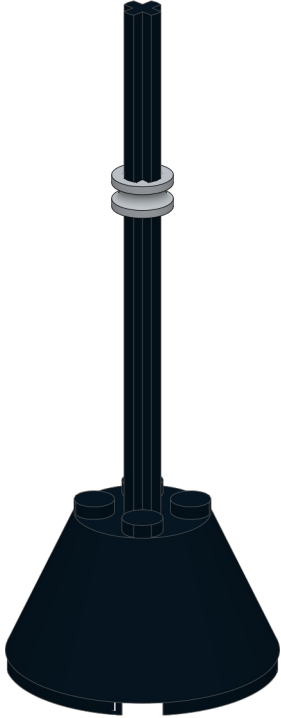
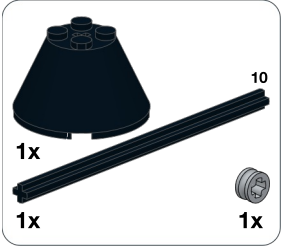

2

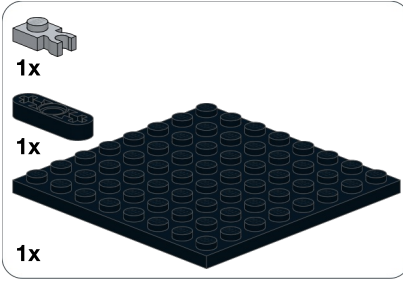

14

